

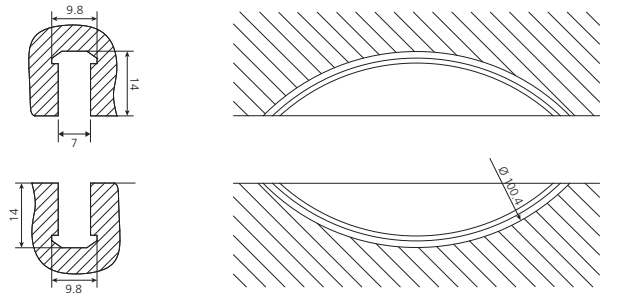

# Tenso P-14

Pat. pend.

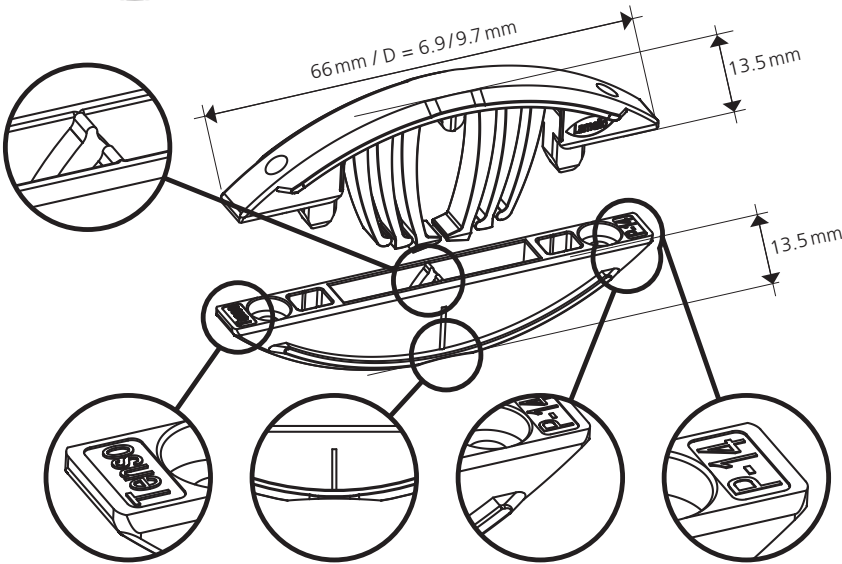

Anzugskraft / Tensile Force: 150 N

Haltekraft / Retention Force: 250 N

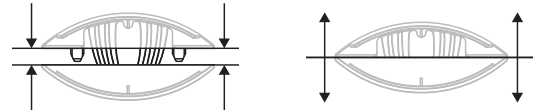

## Immer in Verbindung mit Klebstoff verwenden

zusätzlicher Klebstoff im Verbinder erhöht die Zugfestigkeit um 30%

**Hinweis:** Trockener Zusammenbau mit **Bisco P-14** möglich

## Always use in combination with glue

additional glue in the fitting increases the tensile strength by 30%

**Tip:** Test assembly with **Bisco P-14** possible

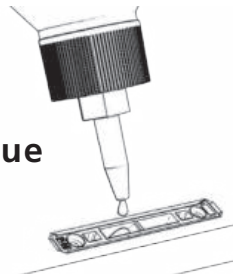

**Wichtig:** Für eine maximale Spannkraft!  
**Important:** For maximum clamping force!

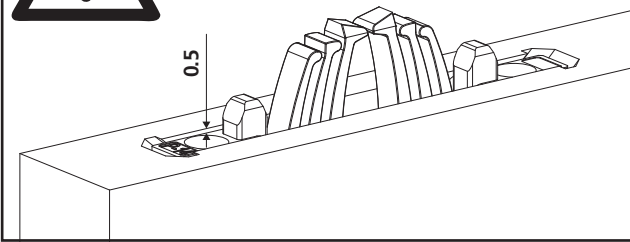

## Zeta P2

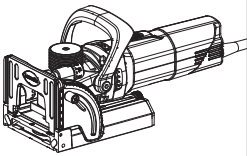

Art.No. 101402



Art.No. 132140 (Diamant)  
DP, Ø 100.4 x 7 x 22 mm



Art.No. 132141  
HW, Ø 100.9 x 7 x 22 mm

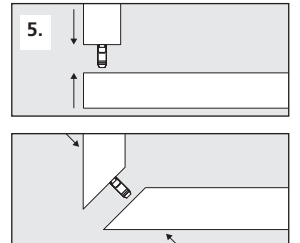
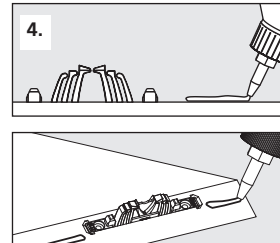
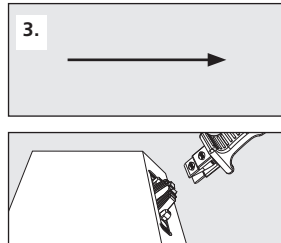
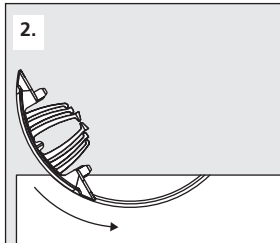
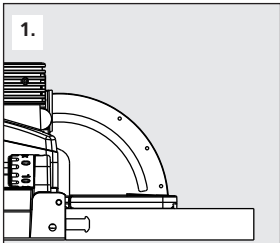
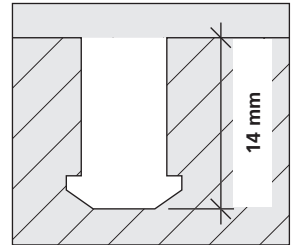
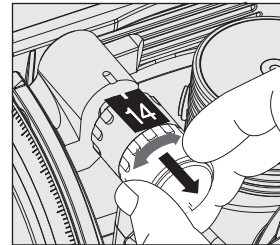

max. 30 min

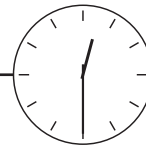

## Anwendungen / Applications

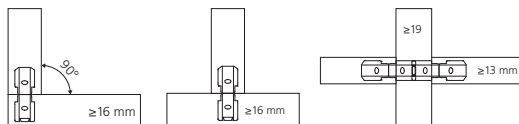

P-System Konfigurator auf unserer Webseite  
P-system configurator on our website  
[www.lamello.com/p-system-configurator](http://www.lamello.com/p-system-configurator)



**P-10**

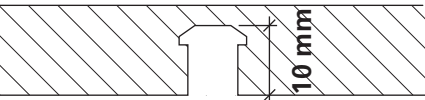

**P-18**

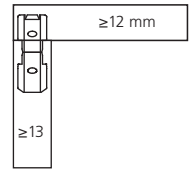
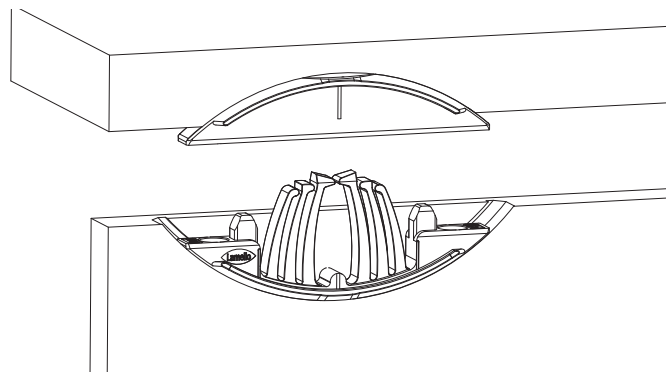
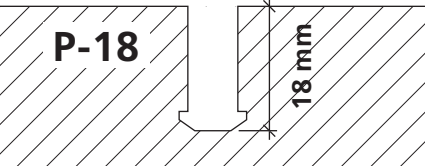

**P-18**

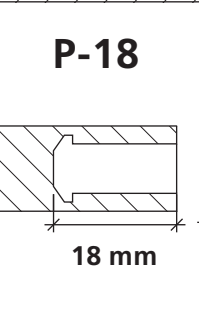

**P-10**

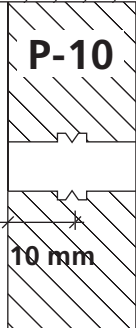

**P-18**

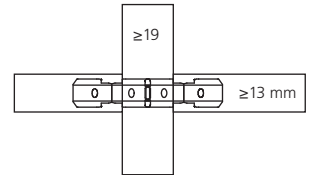
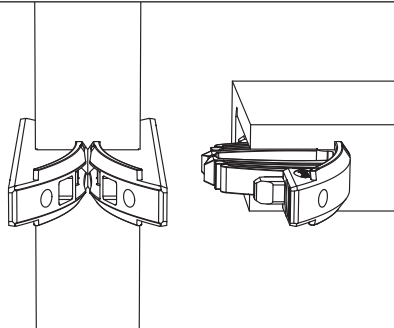
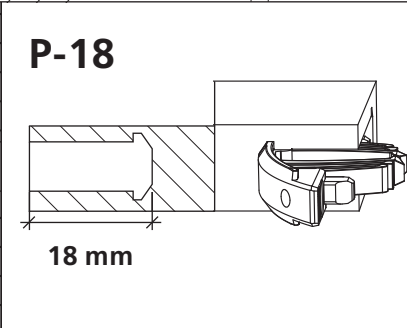

**CNC | Partner network: [www.lamello.com](http://www.lamello.com)**

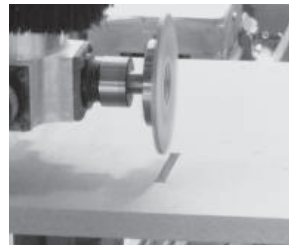
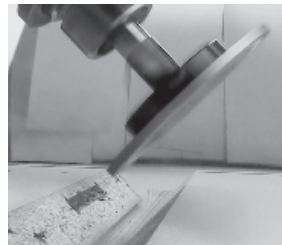
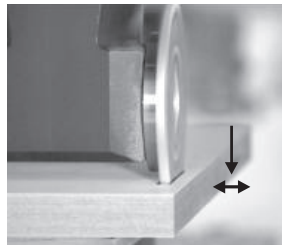
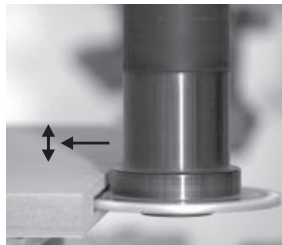
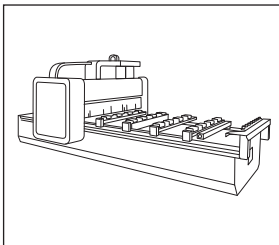

**Art. No. 132142**

DP, 100.4 × 7 × 30 mm  
4 / 6.6 / DTK 48 mm

\* Passend zu allen aufgeführten Fräsdornen  
Suitable for all cutter arbors listed

**Art. No. 132143**

DP, 100.4 × 7 × 40 mm  
4 / 5.5 / DTK 52 mm

**Art. No. 132144**

DP, 100.4 × 7 × 16 mm  
4 / 5.5 / DTK 28 mm



**\* Art. No. 132150**

20 × 50, L = 102 mm

**\* Art. No. 132151**

25 × 60, L = 102 mm

**\* Art. No. 132152**

16 × 50, L = 85 mm

**\* Art. No. 132153**

16 × 55, L = 68 mm

**\* Art. No. 132154**

16 × 50, L = 85 mm, mit Spannfläche (2°-schräg) / with clamping surface (2°-angle)

**\* Art. No. 132155**

20 × 50, L = 85 mm, mit Spannfläche (2°-schräg) / with clamping surface (2°-angle)



**Starter-Set: Tensio P-14 + Vorspann-clip / preload clip**



Paar/Pair/ Paire/Paio	Art. No.
80	145415S
300	145425S

**Vorspann-Clip/  
preload clip**



Stück/Piece/ Pièce/Pezzi	Art. No.
300	145426
1000	145436

**Divario P-18**



Paar/Pair/ Paire/Paio	Art.Nr.
80	145550
300	145560
1000	145570

**Tensio P-14**



Paar/Pair/ Paire/Paio	Art.Nr.
80	145415
300	145425
1000	145435

**Tensio P-10**



Paar/Pair/ Paire/Paio	Art.Nr.
80	145418
300	145428
1000	145438

**Clamex P Medius  
14/10**



Paar/Pair/ Paire/Paio	Art.Nr.
80	145370
300	145371
1000	145357

**Clamex P-14**



Paar/Pair/ Paire/Paio	Art.Nr.
80	145334
300	145346
1000	145356

**Clamex P-10**



Paar/Pair/ Paire/Paio	Art.Nr.
80	145372
300	145373
1000	145374

**Bisco P-14  
Bisco P-10**



Stück/Piece/ Pièce/Pezzi	Art.Nr.
P-10 80	145304
300	145305
P-14 80	145301
300	145302
1000	145303