

# MAXTECH

UAR080x32-Ø12 HL44,4 red

EAN 4031582396300

Wielkern van polyamide met loopvlak van gespoten polyurethaan, wielnaaf op rollager



BETTER MOBILITY. BETTER LIFE.



Foto kan afwijken van het originele product

## Technische data

Wieldiameter	80 mm
Bandbreedte	32 mm
Asgat-Ø	12 mm
Naaflengte	44.4 mm
Temperatuur	- 40 / + 80 °C
Standaard	EN 12532
Eigen gewicht	0.165 kg
Hardheid van de band	Shore D 40
Dyn. draagvermogen	100 kg
Statisch draagvermogen	200 kg

## Afmetingen

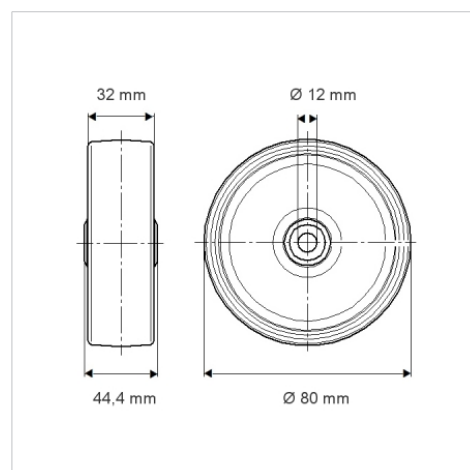

## Kenmerken

Rolweerstand	● ● ● ○ ○
Verplaatsingsgeluid	● ● ● ○ ○
Strepen	● ● ● ● ○
Roest bescherming	● ● ● ○ ○