

Clamex P-10

Pat. pend.

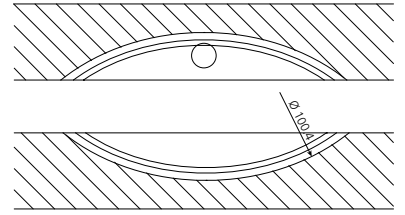
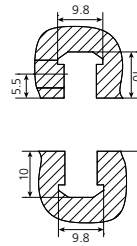
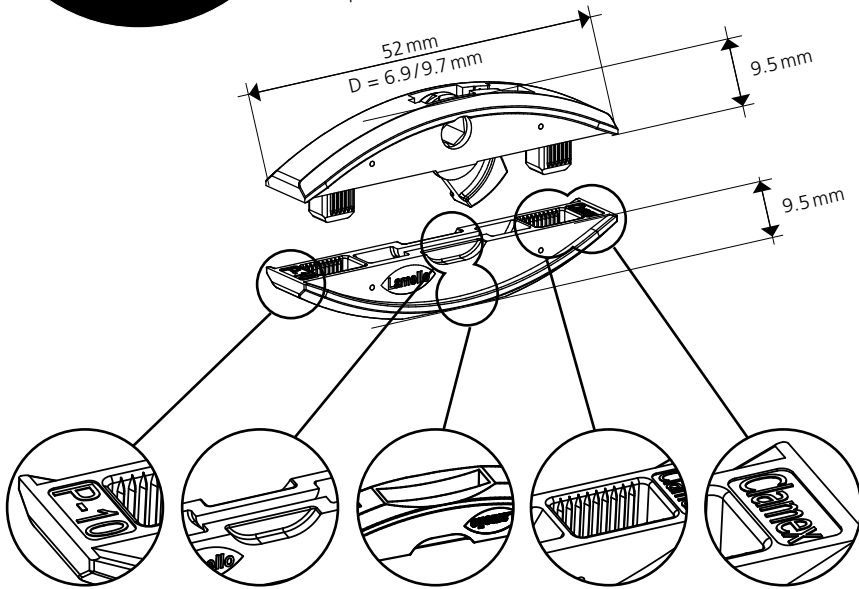

Zugfestigkeit / Tensile strength:

- Spanplatte / particle board:
~ 600 N = 60 kg
- Buche massiv / beech massive:
~ 900 N = 90 kg
- MDF:
~ 600 N = 60 kg

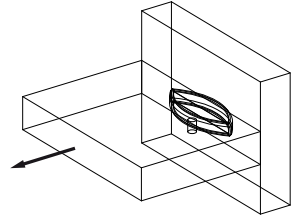

P-System Konfigurator auf unserer Webseite
P-system configurator on our website

Le configurateur P-System sur notre site Internet
Configuratore P-System sul nostro sito web

www.lamello.com/p-system-configurator

P-10

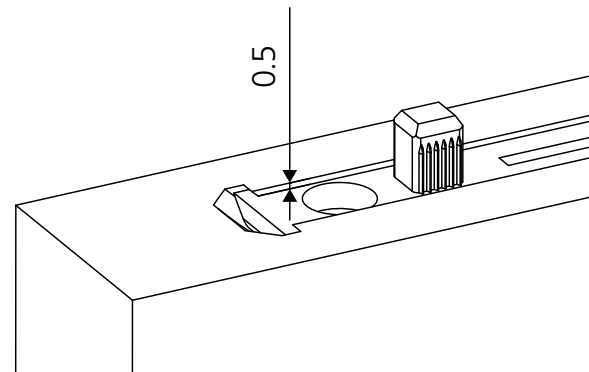
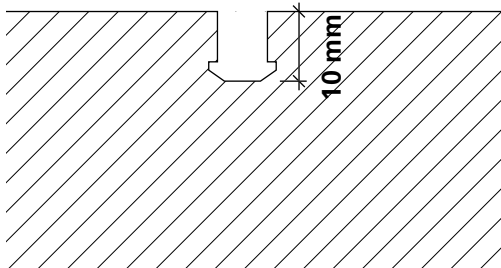

Scharfe Fräser verwenden
Use sharp cutters

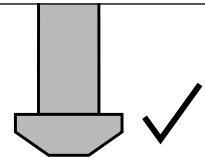
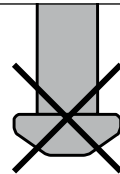

Divario P-18

Tenso P-14

Tenso P-10

Clamex P Medium 14/10

Clamex P-14

Clamex P-10

Bisco P-14 Bisco P-10



Paar/Pair/ Paire/Paio	Art.Nr.
80	145550
300	145560
1000	145570

Paar/Pair/ Paire/Paio	Art.Nr.
80	145415
300	145425
1000	145435

Paar/Pair/ Paire/Paio	Art.Nr.
80	145418
300	145428
1000	145438

Paar/Pair/ Paire/Paio	Art.Nr.
80	145370
300	145371
1000	145357

Paar/Pair/ Paire/Paio	Art.Nr.
80	145334
300	145346
1000	145356

Paar/Pair/ Paire/Paio	Art.Nr.
80	145372
300	145373
1000	145374

Stück/Piece/ Pièce/Pezzi	Art.Nr.
P-10 80	145304
300	145305
P-14 80	145301
300	145302
1000	145303

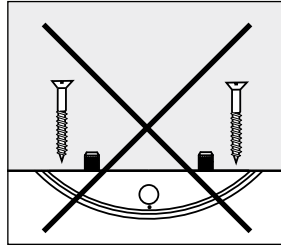
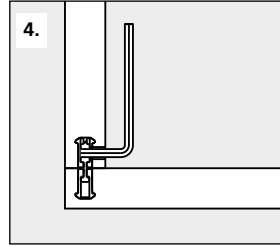
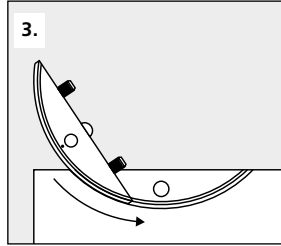
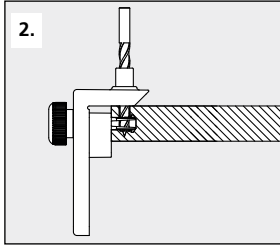
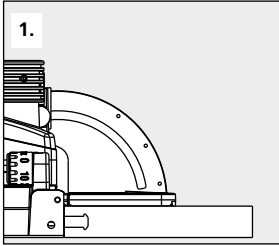
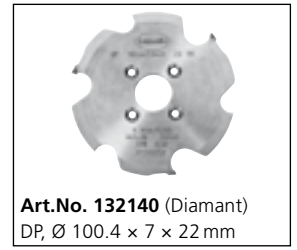
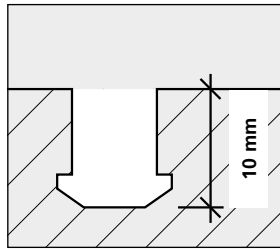
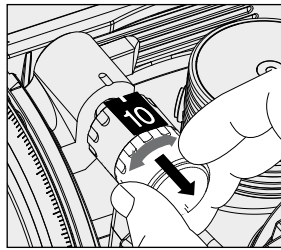
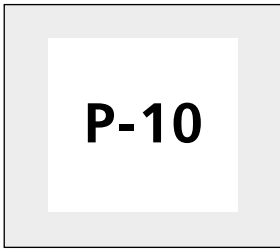
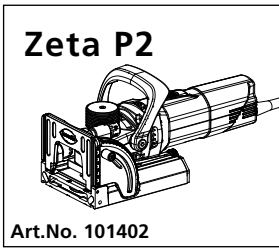

CNC | Partner network: www.lamello.com

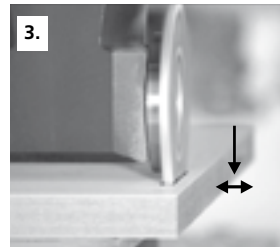
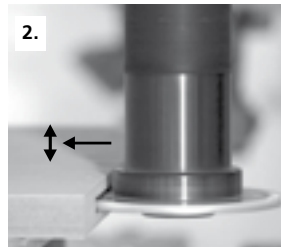
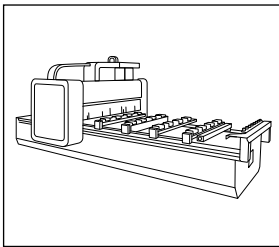

Art. No. 132142
DP, 100.4 × 7 × 30 mm
4 / 6.6 / DTK 48 mm
* Passend zu allen aufgeführten Fräsdornen
Suitable for all cutter arbors listed

Art. No. 132143
DP, 100.4 × 7 × 40 mm
4 / 5.5 / DTK 52 mm

Art. No. 132144
DP, 100.4 × 7 × 16 mm
4 / 5.5 / DTK 28 mm

* **Art. No. 132150**
20 × 50, L = 102 mm

* **Art. No. 132151**
25 × 60, L = 102 mm

* **Art. No. 132152**
16 × 50, L = 85 mm

* **Art. No. 132153**
16 × 55, L = 68 mm

* **Art. No. 132154**
16 × 50, L = 85 mm, mit Spannfläche (2°-schräg) / with clamping surface (2°-angle)

* **Art. No. 132155**
20 × 50, L = 85 mm, mit Spannfläche (2°-schräg) / with clamping surface (2°-angle)

Abdeckkappen / Cover caps
100 Stück / 100 Pieces

90°		45°	
RAL	Art. No.	RAL	Art. No.
9010	335280	9010	335380
9011	335281	9011	335381
1014	335282	1014	335382
1011	335283	1011	335383
8007	335284	8017	335384
8017	335289	7022	335388
9002	335285		
7035	335286		
7040	335287		
7031	335288		
7022	335298		

Art. No. 131556
Ø = 6 / 10 mm
l = 100 / 35 mm

Art. No. 271945
Ø = 4 mm
75 × 55 mm

Art. No. 271945A
Ø = 4 mm
120 × 50 mm

Art. No. 251993
Ø = 4 mm
flexibel

Art. No. 131342
Ø 12 × 40
L = 80 mm

